

13-1000: IMPINGER, MODIFIED TIP, 500ml – Method 5 impinger used for the determination of dust concentration in stack gases. Inlet and outlet tubes are 1/2" OD. Available with graduation lines at 100, 250 and 500ml.

Code #	Description
01	Bottle
02	Stopper
03	Complete

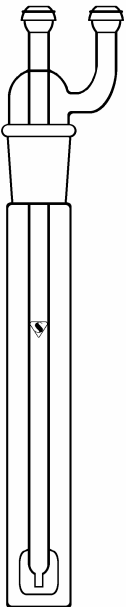

13-1020: IMPINGER, GREENBURG-SMITH, 500ml – Method 5 impinger using a flat impactor plate below orifice tip to trap dust particles. Stopper and bottle are 45/50 o-ring joint. Stopper arms are 28/12 or 18/9 ball o-ring. Available with graduation lines at 100, 250 and 500ml.

18/9 Code #	28/15 Code #	Description
01	04	Bottle
02	05	Stopper
03	06	Complete

Supplied with Aflas o-rings.

13-1040: IMPINGER, MODIFIED TIP, 500ml - Method 5 impinger used for the determination of dust concentration in stack gases. Stopper and bottle are 45/50 o-ring joints. Stopper arms are 28/12 or 18/9 ball o-ring joints. Available with graduated lines at 100, 250 and 500ml.

28/12 Code #	18/9 Code #	Description
01	04	Bottle Only
02	05	Stopper Only
03	06	Complete

Supplied with Aflas O-rings

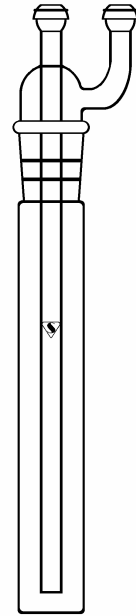

13-1060: IMPINGER, MIDGET, 30ml, MODIFIED TIP – Bottle and stopper are 24/40. Inlet and outlet tubes can be 12/5, 18/9 or plain.

Code #	Joint Size	Description
01	24/40	Bottle Only
02	12/5 Ball O-ring	Stopper
03	12/5 Ball O-ring	Complete
04	18/9 Ball O-ring	Stopper
05	18/9 Ball O-ring	Complete
06	Plain Tube	Stopper
07	Plain Tube	Complete

Supplied with Aflas o-rings. Also available with graduation lines.

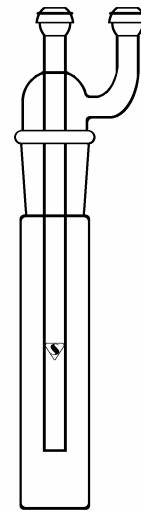

13-1100: IMPINGER, MIDGET, 30ml, TAPERED TIP - Bottle and stopper are 24/40. Inlet and outlet tubes can be 12/5, 18/9 or plain.

Code #	Joint Size	Description
01	24/40	Bottle Only
02	12/5 Ball O-ring	Stopper
03	12/5 Ball O-ring	Complete
04	18/9 Ball O-ring	Stopper
05	18/9 Ball O-ring	Complete
06	Plain Tube	Stopper
07	Plain Tube	Complete

Supplied with Aflas o-rings. Also available with graduation lines.
Please specify when ordering.

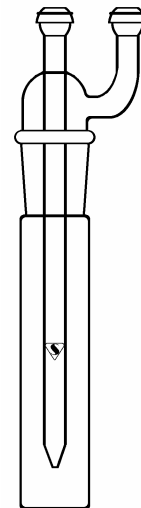

To Order, Call Specialty Glass, Inc. Toll Free 1-800-899-2137

ENVIRONMENTAL

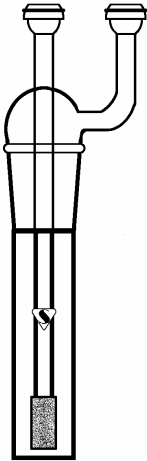

13-1120: IMPINGER, MIDGET - With coarse porosity fritted tip for gas sparging. Bottle and stopper are ₪ 24/40. Inlet and outlet tubes can be ₪ 12/5, ₪ 18/9 or plain.

Code #	Joint Size	Description
01	24/40	Bottle Only
02	12/5 Ball O-ring	Stopper
03	12/5 Ball O-ring	Complete
04	18/9 Ball O-ring	Stopper
05	18/9 Ball O-ring	Complete
06	Plain Tube	Stopper
07	Plain Tube	Complete

Supplied with Aflas o-rings. Also available with graduation lines.
Other porosities available. Please specify when ordering.

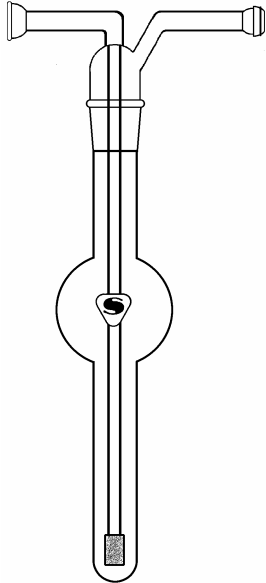

13-1140: BUBBLER, SMOG, 200ml – With coarse porosity fritted tip. Bottle and stopper are ₪ 24/40. Inlet and outlet tubes can be ₪ 12/5 or ₪ 18/9.

Code #	Joint Size	Description
01	24/40	Bottle Only
02	12/5	Stopper
03		Complete
04	18/9	Stopper
05		Complete

Can be supplied with ball o-ring joints. Please specify when ordering.

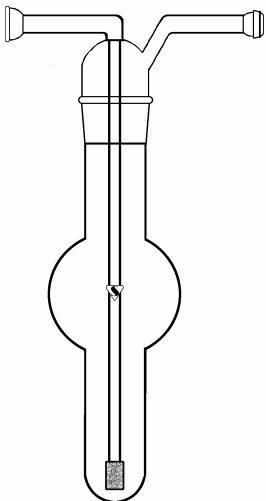

13-1160: BUBBLER, SMOG, SHORT FORM - Similar to 13-1260 but with ₪ 29/42 joints on stopper and bottle.

Code #	Joint Size	Description
01	29/42	Bottle Only
02	12/5	Stopper
03		Complete
04	18/9	Stopper
05		Complete

Inlet and outlet tubes can be ₪ 12/5 or ₪ 18/9. Please specify when ordering.

To Order, Call Specialty Glass, Inc. Toll Free 1-800-899-2137

13-1180: BUBBLER, SMOG, 200ml – With 1mm capillary tip. Bottle and stopper are ₱ 24/40. Inlet tube can be ₱ 12/5 or ₱ 18/9.

Code #	Joint Size	Description
01	24/40	Bottle Only
02	12/5	Stopper
03		Complete
04	18/9	Stopper
05		Complete

Can be supplied with ball o-ring joints. Please specify when ordering.

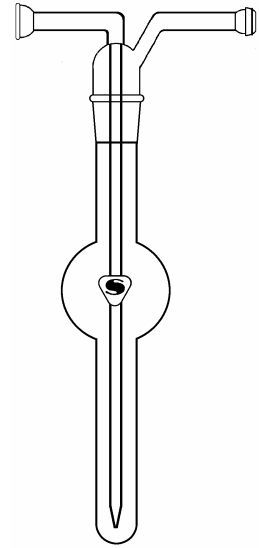

13-1200: BUBBLER, SMOG, SHORT FORM – Similar to 13-1280, but with ₱ 29/42 joints on stopper and bottle. Inlet tube can be ₱ 12/5 or ₱ 18/9.

Code #	Joint Size	Description
01	29/42	Bottle Only
02	12/5	Stopper
03		Complete
04	18/9	Stopper
05		Complete

Can be supplied with ball o-ring joints. Please specify when ordering.

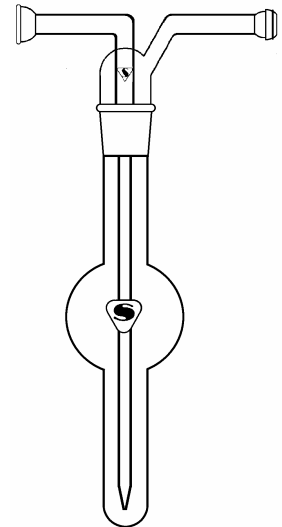

13-1240: U-Tube – 28/15 socket to socket.

Code #	Description
RO14	2" Centers
RO14SP	4" Centers

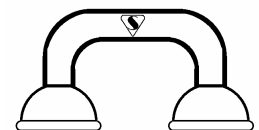

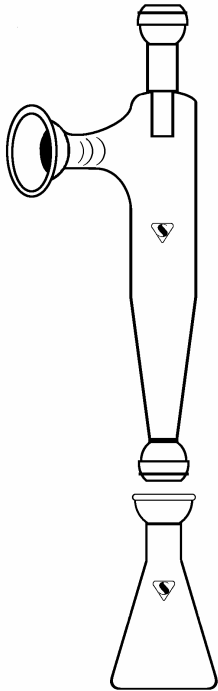

13-1260: CYCLONE – For the collection and separation of dust. With 28/12 ball o-ring joint and 125ml flask.

Code #	Description
RO24	Complete
RO24BOR02	Cyclone Only
RO31	Flask, 125ml

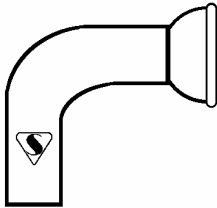

13-1280: ADAPTER, 90° - Socket Joint to 5/8" OD tube.

18/9 Joint Code #	28/12 Joint Code #
01	02

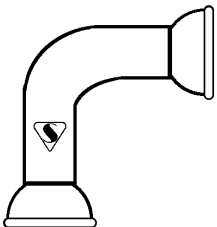

13-1300: ADAPTER, 90° - Socket to socket.

18/9 Joint Code #	28/12 Joint Code #
01	02

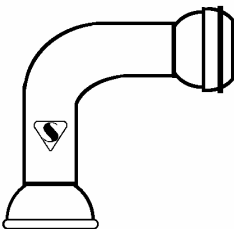

13-1320: ADAPTER, 90° - Socket to Ball o-ring.

Code #	Joint Code
01	18/9 Ball and Socket
02	28/12 Ball and Socket

13-1340: MM5 XAD TRAP, VERTICAL COIL CONDENSER, BALL AND SOCKET S 28/12 – For semi-volatile organic sampling. Vertical style.

Code #	Description
RO39	MM 5 Vertical Coil Condenser
RO36	MM 5 XAD Trap with Coarse Frit

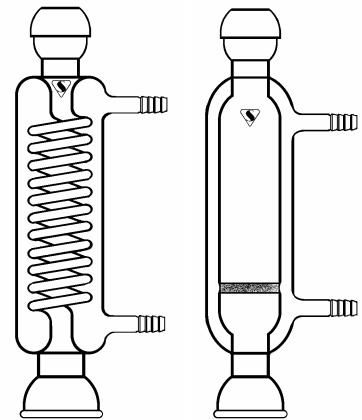

13-1360: MM5 XAD TRAP, VERTICAL COIL CONDENSER, O-RING BALL AND SOCKET S 28/12 – For semi-volatile sampling. Vertical style. Vacuum grease optional. S Ball joints have Teflon coated o-rings.

Code #	Description
RO39BOR	MM 5 Vertical Coil Condenser
RO36BOR	MM 5 XAD Trap with Coarse Frit

Supplied with 'Aflas' O-rings.

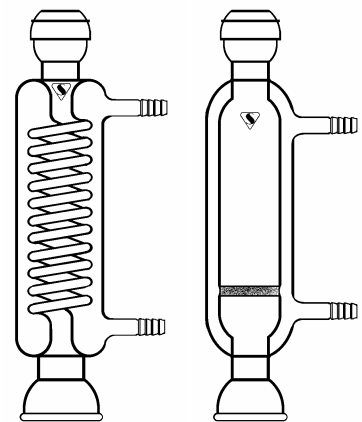

13-1380: MM5 HYBRID BOTTLE – MM5 hybrid bottle has a low profile to eliminate a riser box. SVL 30 center thread. Side arm is a S Ball o-ring.

Code #	S Joint Size
01	28/12
02	SVL Thread #30

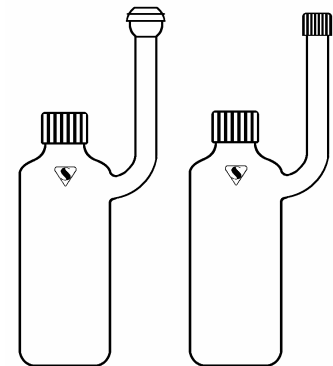

13-1500: PINCH CLAMP, STANDARD TAPER JOINT – Stainless steel clamp provides a secure hole for inner to outer joint connections. Each clamp supplied with a locking screw thread. Sold individually.

Code #	Size	Fits S Joint Size
01	14	14/20 & 14/35
02	19	19/22 & 19/38
03	24	24/25 & 24/40
04	29	29/26 & 29/42
05	45	45/50



To Order, Call Specialty Glass, Inc. Toll Free 1-800-899-2137

ENVIRONMENTAL



13-1520: PINCH CLAMP, SPHERICAL Φ JOINTS – For clamping ball and socket on o-ring joints. Stainless steel construction with thread for locking device. Sold individually.

Code #	Clamp Size
01	12
02	12-L
03	18
04	18-L
05	28
06	35
07	40
08	50
09	60

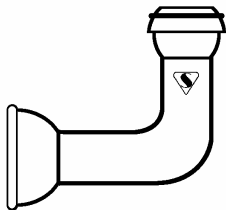

13-1540: CYCLONE BY-PASS ADAPTER, HEAVY WALL - Φ 28/12 joints for connection of probe liner to filter assembly.

Code #	Φ Joint Size
01	28/12 Standard Ball Joint
02	28/12 O-ring Ball Joint

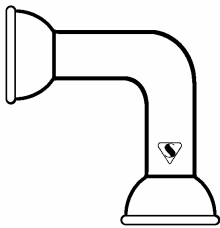

13-1580: DOUBLE 'L' ADAPTER, HEAVY WALL - Φ 28/12 socket joints for connection of filter assembly to first impinger.

Code #	Φ Joint Size
01	28/12

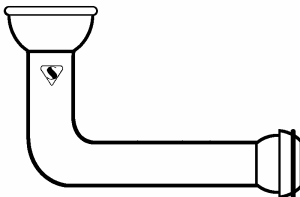

13-1600: FILTER BY-PASS ADAPTER, HEAVY WALL – Adapter provides connection between cyclone by-pass and double 'L' when filter assembly is not needed.

Code #	Φ Joint Size
01	28/12 Standard Ball Joint
02	28/12 O-ring Ball Joint

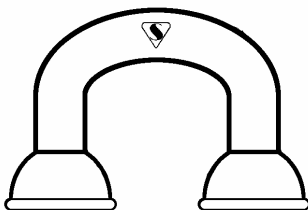

13-1620 IMPINGER CONNECTOR, HEAVY WALL – U-shaped adapter for the connection of socket and O-ring ball joints.

Code #	Φ Joint Size
01	12/5
02	18/9
03	28/15

To Order, Call Specialty Glass, Inc. Toll Free 1-800-899-2137

13-1640: FILTER SUPPORTS, 2" AND 3" HEAVY WALL. Used to support filter disc in Method 5 applications.

Code #	2" Description	Code #	3" Description
01	Inlet Socket Joint	05	Inlet Socket Joint
02	Outlet Ball Joint	06	Outlet Ball Joint
03	Outlet O-ring Ball Joint	07	Outlet Ball O-ring Joint
04	Filter Clamp		

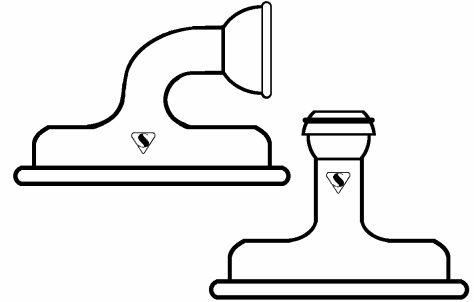

13-1680: PROBE LINERS – Probe liners with 28/12 ball o-ring joint and plain end. 5/8" Heavy Wall Tubing.

Length	Pyrex Code #	Quartz Code #
3' Effective	PLP3	PLQ3
5' Effective	PLP5	PLQ5
7' Effective	PLP7	PLQ7
10' Effective	PLP10	PLQ10
10' Effective		PLQ10-HW

Special Lengths Available

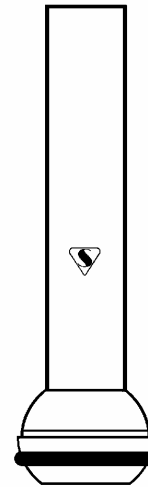

13-1700: PROBE LINERS – Probe liners with plain ends. 5/8" Heavy Wall Tubing.

Length	Pyrex Code #	Quartz Code #
3' Effective	PLP3	PLQ3
5' Effective	PLP5	PLQ5
7' Effective	PLP7	PLQ7
10' Effective	PLP10	PLQ10
10' Effective		PLQ10-HW

Special Lengths Available

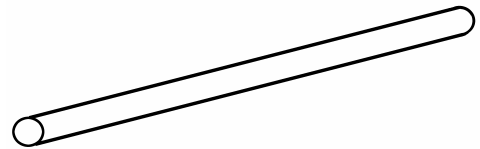

13-1710: PROBE LINERS – Probe liners with Ball o-ring and tapered joint at either end. 5/8" Heavy Wall Tubing.

Length	Pyrex Code #	Quartz Code #
3' Effective	PLP3	PLQ3
5' Effective	PLP5	PLQ5
7' Effective	PLP7	PLQ7
10' Effective	PLP10	PLQ10

Special Lengths Available

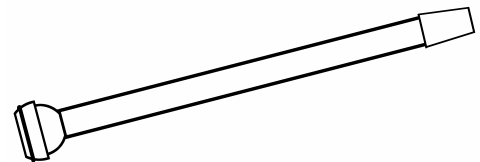

ENVIRONMENTAL

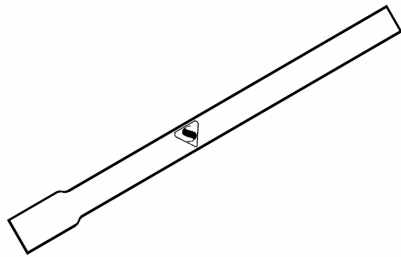

13-1740: VOST PYREX PROBE LINER – 5/16” OD liner with 5/8” glass wool cup.

Code #	Length
V009	3’ Effective
V010	5’ Effective

Available in Quartz upon Request.

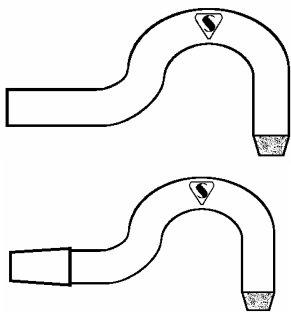

13-1720: METHOD 5 NOZZLES WITH 5/8” SHANK OR 14/35 TAPER.

Size	Pyrex Code #	Quartz Code #
1/8”	NP18	NQ18
3/16”	NP316	NQ316
1/4”	NP14	NQ14
5/16”	NP516	NQ516
3/8”	NP38	NQ38
7/16”	NP716	NQ716
1/2”	NP12	NQ12
9/16”	NP916	NQ916
5/8”	NP58	NQ58
3/4”	NP34	NQ34

Please state either 5/8” shank or 14/35 tapered joint.

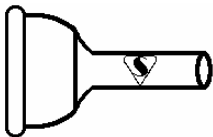

13-1422: ADAPTER – 28/12 socket to 3/8” tube

Code # RO22

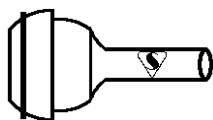

13-1423: ADAPTER – 28/12 ball o-ring to 3/8” tube

Code # RO21

Supplied with Aflas O-ring

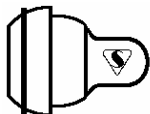

13-1424: STOPPER – 28/12 ball o-ring

Code # RO37BOR

Supplied with Aflas O-ring



13-1425: STOPPER – 28/15 socket

Code # RO38

To Order, Call Specialty Glass, Inc. Toll Free 1-800-899-2137

13-1426: ADAPTER – Filter to first Impinger. 28/12 Socket to Socket.

Code #	Length
RO29	4"
RO29SP	8"

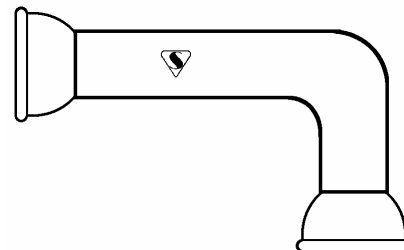

13-1427: ADAPTER – 28/12 to hose barb.

Code #	Description
RO46	Socket
RO46BOR	Ball o-ring

Supplied with Aflas O-ring

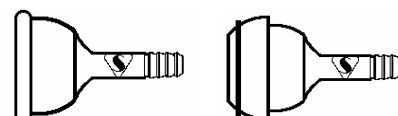

13-1428: ADAPTER – Chrome Six

Code #	Joint Size
RO44	28/15

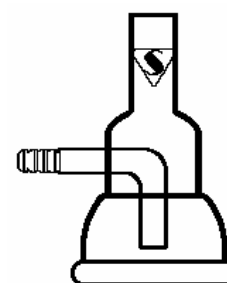

13-1429: ADAPTER – CYCLONE BY-PASS, OFFSET – Ball o-ring to socket

Code #	Joint Size
RO50BOR	28/12 Ball to Socket

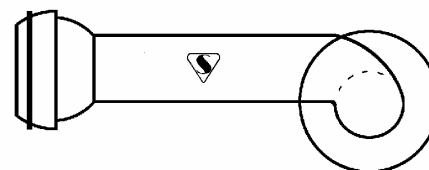

13-1430: ADAPTER, VACUUM – 28/12 socket to hose barb 15°

Code #	Description
RO48	Socket with hose barb
RO47	Socket and hose barb with Thermowell

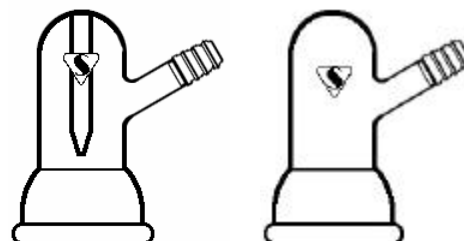

ENVIRONMENTAL

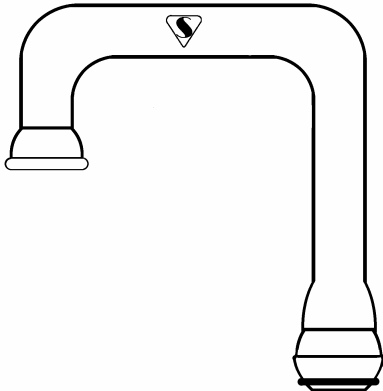

13-1431: ADAPTER, M5 FILTER BYPASS

Code #	Description
RO53BOR	6 3/4" wide, 5 1/2" length, 28/12 socket to 28/12 ball o-ring

Supplied with Aflas O-ring

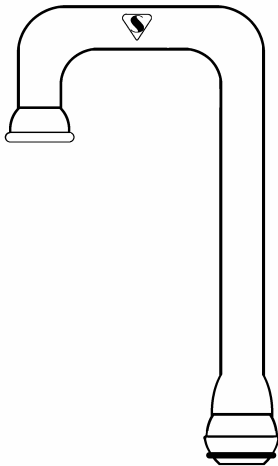

13-1432: ADAPTER, MM5 FILTER BYPASS

Code #	Description
RO30BOR	4" width, 10 1/4" length, 28/12 socket to 28/12 ball o-ring

Supplied with Aflas O-ring

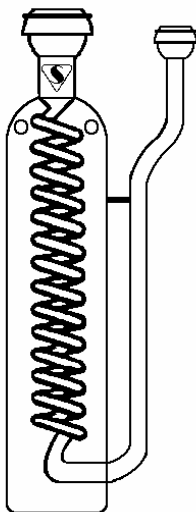

13-1433: MM5 MOISTURE KNOCKOUT CONDENSER – Same height as regular 500ml Impinger.

Code #	Description
RO52	28/12 Ball o-ring joints.

Supplied with Aflas O-ring

To Order, Call Specialty Glass, Inc. Toll Free 1-800-899-2137

13-1434: ORSAT PIPETTES

Code #	Description
OR002	Contact Type
OR003	Sparger

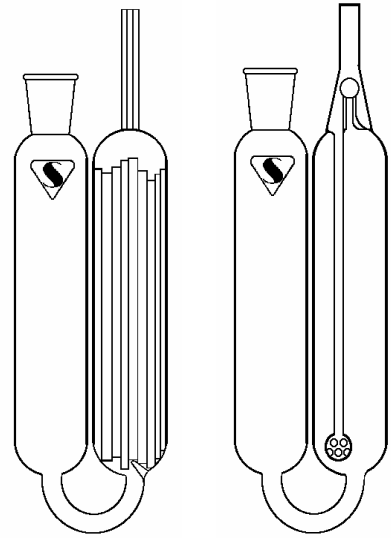

13-1435: ORSAT MANIFOLD

Code #	Description
OR001	3 ports, 3-way valve

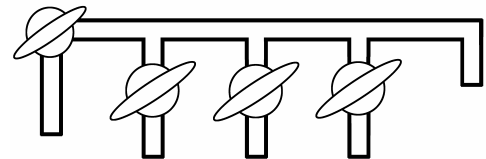

To Order, Call Specialty Glass, Inc. Toll Free 1-800-899-2137

Please visit our Website
www.specialtyglassinc.com
sales@specialtyglassinc.com

Tel: 281-595-2210
Fax: 281-595-2215
Toll Free: 800-899-2137