

# MICRO WARE

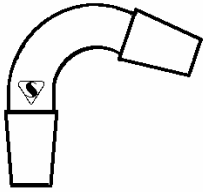

**11-1000: 75° ADAPTER -  $\text{S}$  inner joint at each end.**

Code #	$\text{S}$ Joint
01	14/20
02	19/22

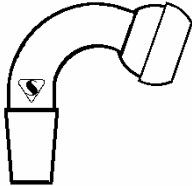

**11-1020: 75° ADAPTER -  $\text{S}$  inner joint at one end and ball joint at other end.**

Code #	$\text{S}$ Joint
01	14/20
02	19/22

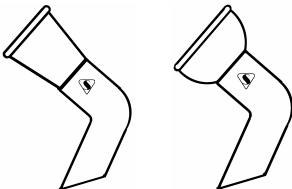

**11-1040: 105° ADAPTER -  $\text{S}$  or  $\text{F}$  joint on one end with drip tip on opposite end.**

Code #	$\text{S}$ Joint	$\text{F}$ Joint
01	14/20	
02	19/22	
03	18/9	
04		14/20
05		19/22
06		18/9

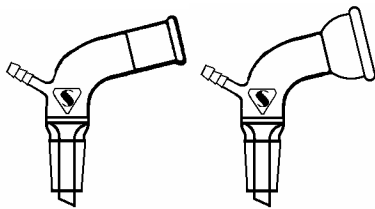

**11-1060: 105° ADAPTER - Drip tip sealed in  $\text{S}$  joint with either  $\text{S}$  or  $\text{F}$  on opposite end.**

Code #	$\text{S}$ Joint Both Ends	$\text{S}$ Joint with 18/9 $\text{F}$
01	14/20	
02	19/22	
03		14/20
04		19/22



**11-1080: STRAIGHT CONNECTING ADAPTER - 18/9  $\text{F}$  joint at top and a  $\text{S}$  inner joint at bottom.**

Code #	$\text{S}$ Joint
01	14/20
02	19/22

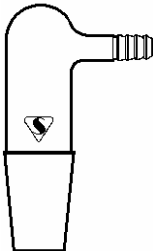

**11-1100: ADAPTER - With hose connection at top and  $\text{S}$  inner joint at bottom.**

Code #	$\text{S}$ Joint
01	14/20
02	19/22

To Order, Call Specialty Glass, Inc. Toll Free 1-800-899-2137

# MICRO WARE

**11-1120: INLET ADAPTER** - Will accommodate gas inlet tube with  $\text{S}$  inner joint at bottom.

Code #	$\text{S}$ Joint
01	14/20
02	19/22

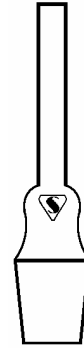

**11-1140: ADAPTER - Kjeldahl Trap** with  $\text{S}$  or  $\text{F}$  joint at top and bottom.

Code #	$\text{S}$ Joint	Code #	$\text{F}$ Joint
01	14/20	03	18/9
02	19/22		

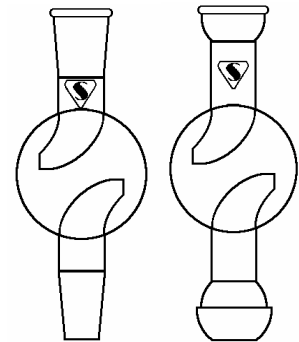

**11-1160: THREE-WAY ADAPTER** - Two  $\text{S}$  upper inlet joints,  $\text{S}$  side take-off joint with drip tip and lower inner  $\text{S}$  joint.

Code #	$\text{S}$ Joint
01	14/20
02	19/22

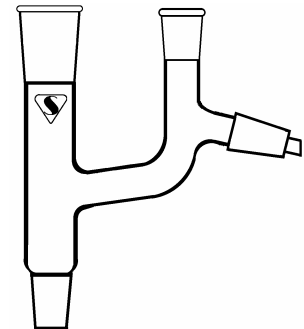

**11-1180: CLAISEN ADAPTER** -  $\text{S}$  10/18 outer joint at top of side tube with an 18/9  $\text{F}$  joint at end of take-off tube. Main tube has  $\text{S}$  inner and outer joints of the same size. A 1" immersion thermometer will fit into the side tube.

Code #	$\text{S}$ Joint
01	14/20
02	19/22

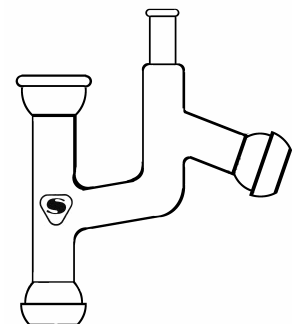

To Order, Call Specialty Glass, Inc. Toll Free 1-800-899-2137

# MICRO WARE

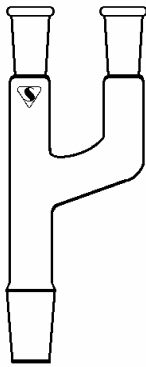

**11-1220: ADAPTER, CLAISEN** -  $\text{GG}$  joints of the same size on all three arms.

Code #	$\text{GG}$ Joint
01	14/20
02	19/22

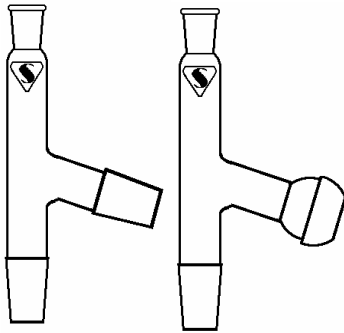

**11-1240: THREE WAY ADAPTER** - Side and bottom  $\text{GG}$  inner joint or  $\text{SG}$  side joint. Side tube is set at a 75° angle. Top 10/18 joint will accept a 1" immersion thermometer.

Code #	$\text{GG}$ Joint	Code #	$\text{SG}$ Joint
01	14/20	03	14/20
02	19/22	04	19/22

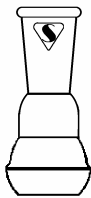

**11-1260: STRAIGHT CONNECTING ADAPTER** -  $\text{GG}$  Top joint with an 18/9 ball joint on bottom.

Code #	$\text{GG}$ Joint
01	14/20
02	19/22



**11-1300: STRAIGHT CONNECTING ADAPTER** -  $\text{GG}$  joints at top and bottom of same size.

Code #	$\text{GG}$ Joint
01	14/20
02	19/22

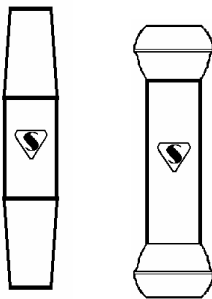

**11-1320: STRAIGHT CONNECTING ADAPTERS** -  $\text{SG}$  joints at top and bottom of same size. Length: 100mm

Code #	$\text{SG}$ Joint	Code #	$\text{GG}$ Joint
01	18/9	02	14/20
		03	19/22

To Order, Call Specialty Glass, Inc. Toll Free 1-800-899-2137

**11-1340: ALLIHN CONDENSER** - Sealed-through drip tube with  $\text{S}$  joint at bottom and hose connections on either side at top and bottom.

Code #	$\text{S}$ Joint
01	19/22

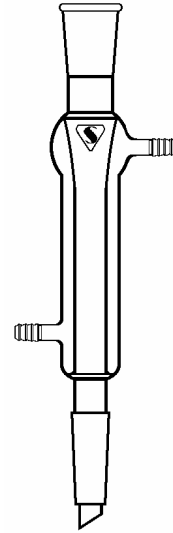

**11-1380: STRAIGHT CONNECTING ADAPTER** -  $\text{S}$  or  $\text{F}$  outer joint at top and inner joint of same size at bottom.

Code #	$\text{S}$ Joint	Code #	$\text{S}$ Joint
01	18/9	02	14/20
		03	19/22

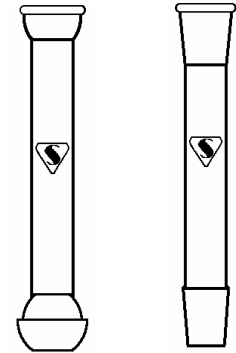

**11-1400: VACUUM ADAPTER – STRIAIGHT** - Inner and outer  $\text{S}$  joints at top and bottom. Side hose connection for vacuum or introduction of gas.

Code #	$\text{S}$ Joint
01	14/20
02	19/22

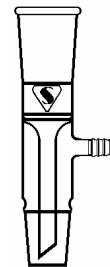

**11-1420: STRAIGHT ADAPTER** - Inner and outer  $\text{S}$  joints at top and bottom with side hose connection for vacuum or introduction of gas.

Code #	$\text{S}$ Joint
01	14/20
02	19/22

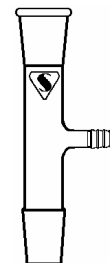

*To Order, Call Specialty Glass, Inc. Toll Free 1-800-899-2137*

# MICRO WARE

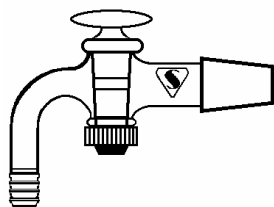

**11-1440: ADAPTER WITH STOPCOCK - A 2mm Teflon® stopcock is sealed between  $\text{S}$  inner joint and top 90° hose connection.**

Code #	$\text{S}$ Joint
01	14/20
02	19/22

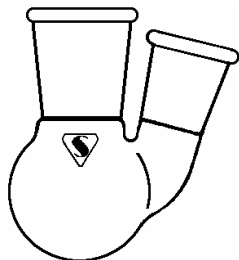

**11-1460: TWO-NECK, ROUND BOTTOM FLASK -  $\text{S}$  Outer joints.**

Capacity ml	Center $\text{S}$ Joint	Code # For $\text{S}$ Side Neck		
		10/18	14/20	19/22
15	14/20	01	13	25
	19/22	02	14	26
25	14/20	03	15	27
	19/22	04	16	28
50	14/20	05	17	29
	19/22	06	18	30
100	14/20	07	19	31
	19/22	08	20	32
250	14/20	09	21	33
	19/22	10	22	34
500	14/20	11	23	35
	19/22	12	24	36



**11-1480: ROUND BOTTOM, SHORT NECK FLASK -  $\text{S}$  Outer joint.**

Capacity ml	Code Numbers	
	14/20 $\text{S}$ JOINT	19/22 $\text{S}$ JOINT
5	01	11
10	02	12
15	03	13
25	04	14
35	05	15
50	06	16
100	07	17
250	08	18
300	09	19
500	10	20



**11-1500: ROUND BOTTOM, LONG NECK FLASK -  $\text{S}$  Outer joint.**

Capacity ml	Code Numbers	
	14/20 $\text{S}$ JOINT	19/22 $\text{S}$ JOINT
5	01	11
10	02	12
15	03	13
25	04	14
35	05	15
50	06	16
100	07	17
250	08	18
300	09	19
500	10	20

*To Order, Call Specialty Glass, Inc. Toll Free 1-800-899-2137*

**11-1520: FLASK, PEAR SHAPED, THREE NECK - With  $\overline{S}$  outer joints.**

Capacity ml	Center $\overline{S}$ Joint	Code Numbers $\overline{S}$ Side Necks	
		14/20 Joint	19/22 Joint
25	14/20	01	11
	19/22	02	12
50	14/20	03	13
	19/22	04	14
100	14/20	05	15
	19/22	06	16
250	14/20	07	17
	19/22	08	18
500	14/20	09	19
	19/22	10	20

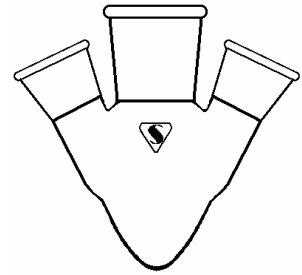

**11-1540: FLASK, ROUND BOTTOM, THREE NECK - With  $\overline{S}$  outer joints.**

Capacity ml	Center $\overline{S}$ Joint	Code Numbers $\overline{S}$ Side Necks	
		14/20 Joint	19/22 Joint
25	14/20	01	11
	19/22	02	12
50	14/20	03	13
	19/22	04	14
100	14/20	05	15
	19/22	06	16
250	14/20	07	17
	19/22	08	18
500	14/20	09	19
	19/22	10	20

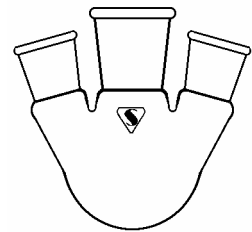

**11-1560: FLASK, ROUND BOTTOM, FOUR NECK - With  $\overline{S}$  outer joints.**

Capacity ml	Center $\overline{S}$ Joint	Code Numbers $\overline{S}$ Side Necks	
		14/20 Joint	19/22 Joint
25	14/20	01	11
	19/22	02	12
50	14/20	03	13
	19/22	04	14
100	14/20	05	15
	19/22	06	16
250	14/20	07	17
	19/22	08	18
500	14/20	09	19
	19/22	10	20

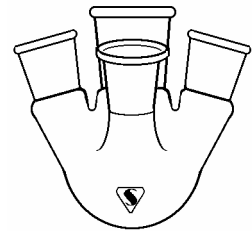

**11-1580: FLASK, PEAR SHAPED, TWO NECK - With  $\overline{S}$  outer joint.**

Capacity ml	Center $\overline{S}$ Joint	Code Number $\overline{S}$ Side Neck	
		14/10 Joint	19/22 Joint
10	14/20	01	
	19/22	02	
15	14/20	03	11
	19/22	04	12
20	14/20	05	13
	19/22	06	14
25	14/20	07	15
	19/22	08	16
50	14/20	09	17
	19/22	10	18

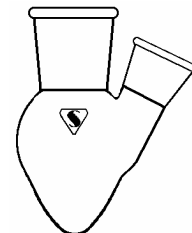

*To Order, Call Specialty Glass, Inc. Toll Free 1-800-899-2137*

# MICRO WARE



## 11-1600: FLASK, PEAR SHAPED, SHORT NECK - With $\Phi$ outer joint.

### Code Numbers

Capacity ml	14/20 Joint	19/22 Joint
2	01	12
5	02	13
10	03	14
15	04	15
20	05	16
25	06	17
35	07	18
50	08	19
65	09	20
100	10	21
250	11	22

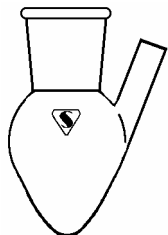

## 11-1620: FLASK, PEAR SHAPED, SIDE INLET TUBE - Short neck with $\Phi$ outer joint.

### Code Numbers

Capacity ml	14/10 Joint	19/22 Joint
5	01	09
10	02	10
15	03	11
20	04	12
25	05	13
50	06	14
100	07	15
250	08	16

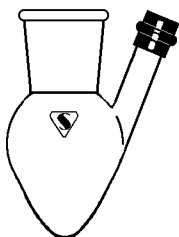

## 11-1640: FLASK, PEAR SHAPED, SIDE INLET TUBE

Same as 11-1620 but supplied with rubber thermometer fitting on side inlet tube.

Use 11-1620 for Code Number specifications.

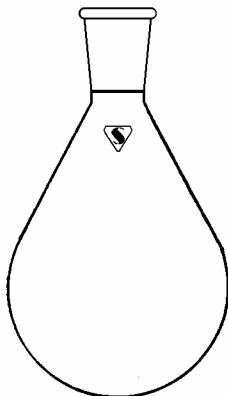

## 11-1660: FLASK, RECOVERY, KJELDAHL

Code #	Capacity ml	$\Phi$ Joint Size
01	10	14/20
02	10	19/22
03	25	14/20
04	50	19/22
05	50	14/20
06	100	19/22
07	100	14/20
08	100	19/22
09	200	14/20
10	200	19/22

To Order, Call Specialty Glass, Inc. Toll Free 1-800-899-2137

**11-1680: FLASK, ERLLENMEYER - With  $\text{S}$  outer joint.**

Capacity ml	Code Numbers	
	14/20 Joint	19/22 Joint
5	01	07
10	02	08
15	03	09
25	04	10
50	05	11
100	06	12



**11-1700: FUNNEL, FILTER, BUCHNER - With delivery stem and vacuum hose connection.**

Code #	Capacity ml	$\text{S}$ Joint Size
01	15	14/20
02	30	14/20
03	60	14/20
04	15	19/22
05	30	19/22
06	60	19/22

See Item #10-1080 (Fritted Ware) for more available sizing.

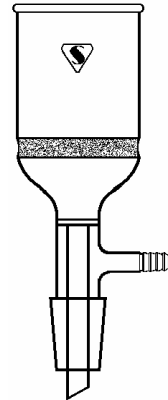

**11-1720: FUNNEL, POWDER**

Code #	$\text{S}$ Joint Size
01	14/20
02	19/22

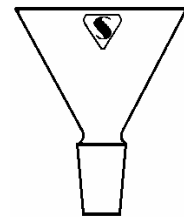

**11-1740: DISTILLING COLUMN -  $\text{S}$  joints of the same size are at top and bottom of straight distilling column. Column length is 110mm with packing support at bottom.**

Code #	$\text{S}$ Joint Size	
01	14/20	Other Lengths Available
02	19/22	
03	18/9	

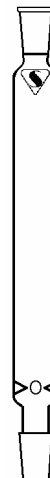



# MICRO WARE

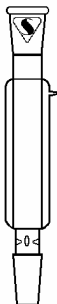

**11-1760: DISTILLING COLUMN, VACUUM JACKETED** - Joints of the same size are at top and bottom of straight distilling column. Column length is 110mm with packing support at bottom.

Code #	Joint Size	
01	14/20	Other lengths available.
02	19/22	
03	18/9	



**11-1780: DISTILLING COLUMN, VIGREUX** - Joints of the same size are at top and bottom of column.

Code #	Joint Size	
01	14/20	Other lengths available.
02	19/22	
03	18/9	

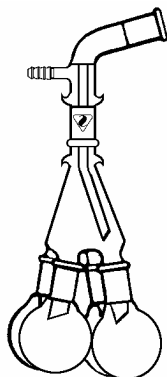

**11-1800: DISTILLING RECEIVER, 105°** - Consists of vacuum adapter, distributing adapter and four 15ml receiving flasks. All lower joints are 14/20 with top joint being either 14/20 or 19/22. Supplied with stainless steel springs.

Code #	Joint Size
01	14/20
02	19/22

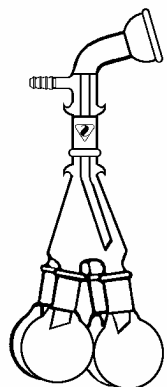

**11-1820: DISTILLING RECEIVER 105°** - Same as 11-1800 except top joint is an 18/9 socket. Supplied with stainless steel springs.

Code #	Joint Size
01	18/9

To Order, Call Specialty Glass, Inc. Toll Free 1-800-899-2137

# MICRO WARE

**11-1860: DISTILLING HEAD** - The bottom and side joint are the same type. The top joint is  $\text{S } 10/18$  for 1" thermometer. Condenser length is 110mm.

Code #	Joint Size
01	14/20
02	19/22

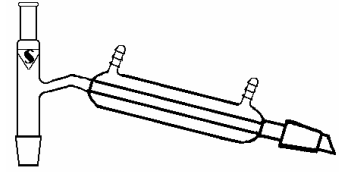

**11-1880: DISTILLING HEAD** - Same as 11-1860 except take-off joint is 18/9 ball.

Glass Stopcock		Teflon Stopcock	
Code #	Joint Size	Code #	Joint Size
01	14/20	03	14/20
02	19/22	04	19/22

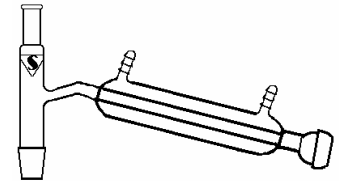

**11-1900: DISTILLING HEAD, COLD FINGER** - The bottom joints are of the same type. The top joint is  $\text{S } 10/30$  for 3" thermometer.

Code #	Joint Size
01	14/20
02	19/22

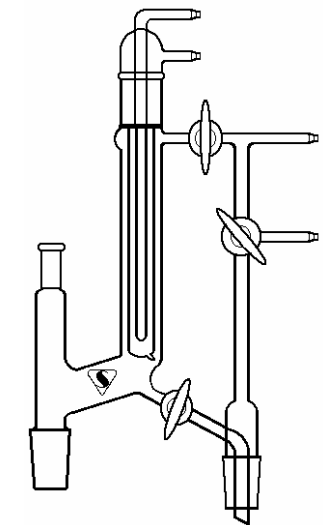

**11-1960: DISTILLING HEAD** - The bottom and take-off joints are of the same size. The top joint is  $\text{S } 10/18$  for a 1" thermometer. Condenser length is 100mm.

Code #	Joint Size
01	14/20
02	19/22

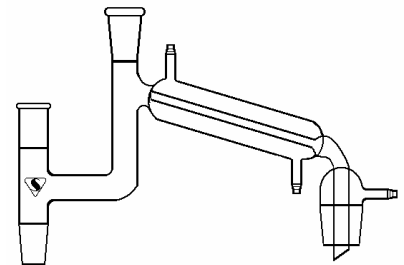

**11-1980: DISTILLING HEAD, SHORT PATH** - For small quantity distillations. Side and lower joints are of the same size. Top thermometer joint is  $\text{S } 10/30$ .

Code #	Joint Size
01	14/20
02	19/22

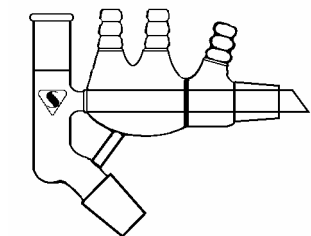

To Order, Call Specialty Glass, Inc. Toll Free 1-800-899-2137

# MICRO WARE

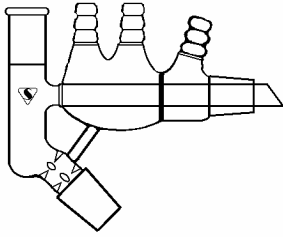

**11-2000: DISTILLING HEAD, SHORT PATH, VIGREUX** - For small quantity distillations. Side and lower joints are of the same size. Top thermometer joint is  $\text{S}$  10/30. Vigreux indentations for increased surface area.

Code #	Joint Size
01	14/20
02	19/22

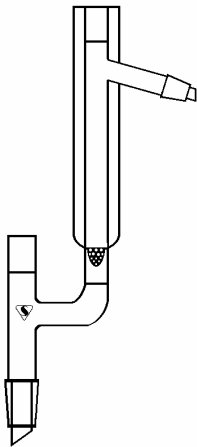

**11-2020: DISTILLING HEAD, JACKETED** - The bottom and take-off joints are of the same size. The two top joints are 10/18 for 1" thermometer. Column length is 200mm. Honeycomb packing support at bottom.

Code #	$\text{S}$ Joint Size
01	14/20
02	19/22

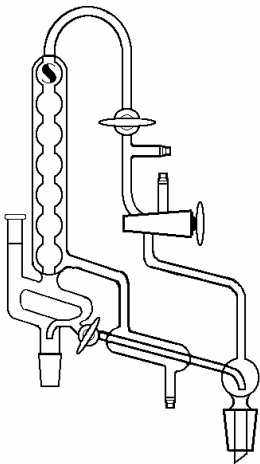

**11-2040: DISTILLING HEAD** - The top joint is 10/18 for 1" immersion thermometer. Two bottom joints are of the same member. All joints are  $\text{S}$ .

Glass Stopcock Code #	$\text{S}$ Joint Size	Teflon Stopcock Code #	$\text{S}$ Joint Size
01	14/20	03	14/20
02	19/22	04	19/22

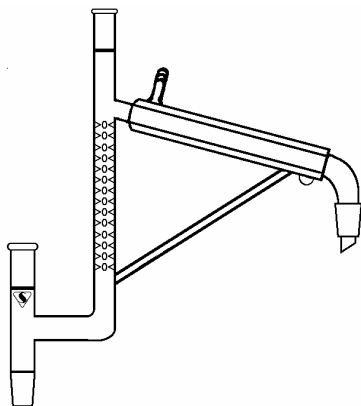

**11-2060: DISTILLING HEAD, VIGREUX** - A  $\text{S}$  10/18 joint is at top of side tube which is free for a 1" immersion thermometer. All other joints are  $\text{S}$  of the same size. The Vigreux section is 100mm and condenser jacket length is 110mm.

Code #	$\text{S}$ Joint Size
01	14/20
02	19/22

To Order, Call Specialty Glass, Inc. Toll Free 1-800-899-2137

**11-2140: DISTILLATION APPARATUS, STEAM, KJELDAHL** - Consists of steam generator, Kjeldahl type trap steam inlet tube, condenser, vacuum adapter and 15ml receiving flask. Condenser joints are  $\text{S}$  18/9. All other joints are  $\text{S}$  14/20. Steam, produced in the bottom part of the generator, surrounds the inner part that holds the sample and also enters this part through the side arm and steam inlet tube. The bulb in this tube prevents back-flow when heating is stopped.

Code #	Description
01	Complete
02	Generator
03	Steam Inlet Tube
04	Condenser
05	Vacuum Adapter
06	Receiving Flask

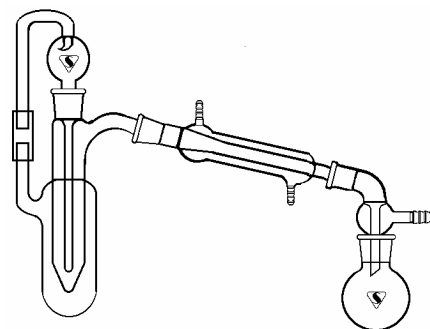

**11-2160: DISTILLING HEAD, VIGREUX** - Claisen-type head with a Vigreux column as a side arm. The top joint is a 10/30  $\text{S}$  which will accommodate a 3" immersion thermometer.

Code #	$\text{S}$ Joint Size	$\text{S}$ Joint Size
01	14/20	
02	19/22	
03		14/20 with 18/9 Ball
04		19/22 with 18/9 Ball

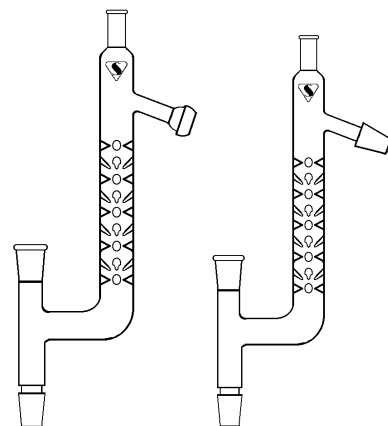

**11-2180: DISTILLING HEAD, VIGREUX, VACUUM JACKETED** - A  $\text{S}$  10/18 joint is at top of side tube which is free for a 1" immersion thermometer. All other joints are  $\text{S}$  of the same size. The Vigreux section is 100mm and condenser jacket length is 110mm.

Code #	$\text{S}$ Joint Size
01	14/20
02	19/22

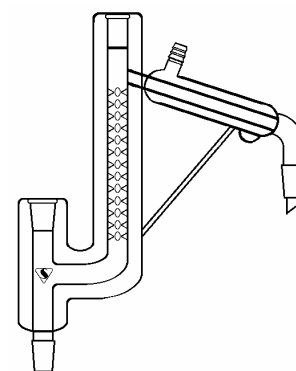

**11-2200: FILTERING APPARATUS** -  $\text{S}$  19/22 joints. For vacuum filtration. Consists of 50ml Erlenmeyer flask and filter assembly.

Code #	Porosity
01	XC
02	C
03	M
04	F
Complete as Shown	

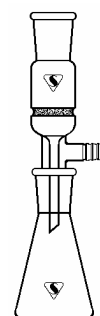

# MICRO WARE

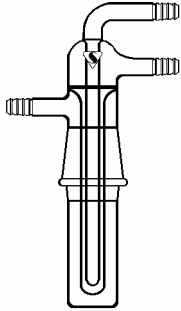

**11-2220: SUBLIMATOR – MICRO -** For use in the sublimation of small quantities of material. Employs cold finger type condenser for the collection of sublimate.

Code #	Description
01	Condenser $\text{S}$ 24/25 joint
02	Flask 30ml Capacity
03	Complete

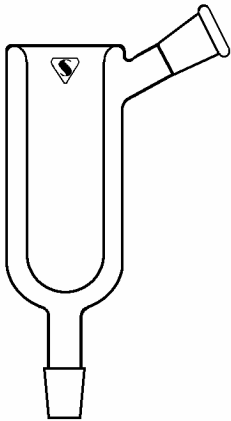

**11-2240: CONDENSER, DEWAR -**  $\text{S}$  joints at the top and bottom are of the same size. Inside depth is 90mm x 36mm I.D.

Code #	$\text{S}$ Joint
01	14/20
02	19/22
03	18/9

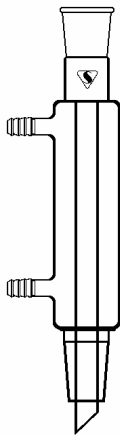

**11-2340: CONDENSER, LIEBIG -** Jacket length is 110mm with  $\text{S}$  outer joint at top and inner  $\text{S}$  joint at bottom.

Code #	$\text{S}$ Joint Size
01	14/20
02	19/22

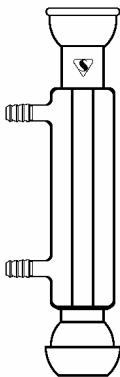

**11-2360: CONDENSER, LIEBIG -** Same as 11-2340 except with  $\text{S}$  joints.

Code #	$\text{S}$ Joint Size
01	18/9

To Order, Call Specialty Glass, Inc. Toll Free 1-800-899-2137

**11-2380: CONDENSER, REFLUX COIL TYPE** - Coil section is approximately 100mm in length.  $\frac{5}{16}$  outer joint at top and inner  $\frac{5}{16}$  joint at bottom.

Code #	$\frac{5}{16}$ Joint Size
01	14/20
02	19/22

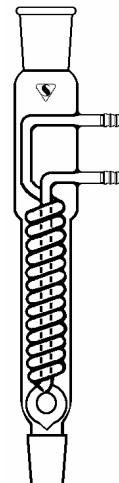

**11-2260: FUNNEL, SEPARATORY, SQUIBB** - Pear shaped funnel with 2mm Teflon stopcock and drip tip bottom joint. Supplied with stopper.

Code #	Capacity ml	$\frac{5}{16}$ Joint Size
01	30	14/20
02	30	19/22
03	60	14/20
04	60	19/22
05	125	14/20
06	125	19/22

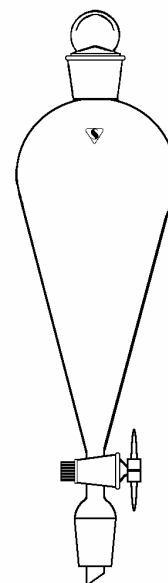

**11-2280: FUNNEL, SEPARATORY, CYLINDRICAL** - With 2mm Teflon stopcock. Supplied with stopper.

Code #	Capacity ml	$\frac{5}{16}$ Joint Size
01	10	14/20
02	10	19/22
03	25	14/20
04	25	19/22
05	50	14/20
06	50	19/22
07	125	14/20
08	125	19/22

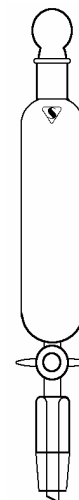

*To Order, Call Specialty Glass, Inc. Toll Free 1-800-899-2137*

# MICRO WARE

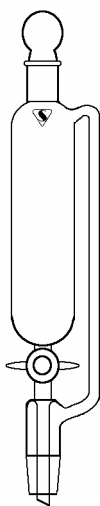

**11-2300: FUNNEL, SEPARATORY, CYLINDRICAL, GRADUATED - Same as 11-2280 but with dual scale graduations.**

Code #	Capacity ml	Joint Size
01	10	14/20
02	10	19/22
03	25	14/20
04	25	19/22
05	50	14/20
06	50	19/22

**11-2320: FUNNEL, SEPARATORY, CYLINDRICAL - 2mm Teflon stopcock and pressure equalizing arm. Supplied with stopper.**

Code #	Capacity ml	Joint Size
01	10	14/20
02	10	19/22
03	25	14/20
04	25	19/22
05	50	14/20
06	50	19/22
07	125	14/20
08	125	19/22

*To Order, Call Specialty Glass, Inc. Toll Free 1-800-899-2137*

Specialty Glass, Inc. welcomes your inquiries for special apparatus or for your own unique design. Please enclose a measured drawing for new designs and/or a measured drawing or photograph for reproduced designs. Should we have any questions, we will contact you. Upon receipt of your inquiry, we will reply with a price quote and delivery date estimate. Should you have any problems designing your apparatus, we will be pleased to assist in person or by telephone, fax or email.